

POP RECESSED

ROUND 12
STATIC WHITE, FULL SPECTRUM

LUMENWERX

Project: _____
Type: _____

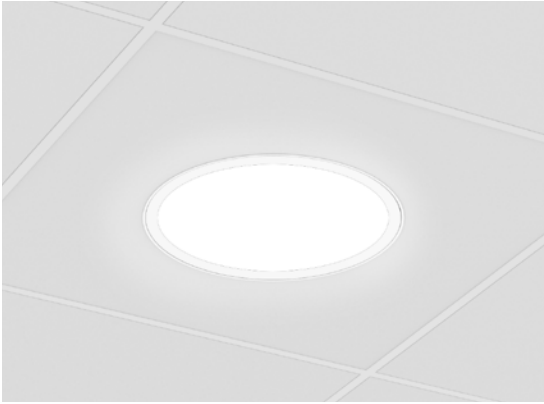

Flush lens

DESCRIPTION

POP Recessed features a uniformly luminous diffuser that sits flush with the ceiling. The diffuser and light engine form a fully enclosed unit secured by a twist-and-lock mechanism for easy maintenance with no exposed hardware. POP Recessed delivers up to 101 LPW and installs in grid or gypsum board ceilings.



IC RATED

Up to 101 lm/w performance

ORDER GUIDE

LUMINAIRE ID	SIZE	OPTICS	LENS	LIGHT SOURCE	CRI	LUMEN PACKAGES
POROR	12	ULO	FH			
POROR - Pop Round Recessed	12 - 12" diameter	ULO - Uniform Lambertian Optic	FH - Flush	SW - Static white FS - Full spectrum	80 - 80CRI 90 - 90CRI	750 - Min. low output 750lm 900 ¹ - Medium output 900lm 1100 ¹ - Max. high output 1100lm #### - Other required lm ¹ Not available with full spectrum.

COLOR TEMP.	VOLTAGE	DRIVER ²	ELECTRICAL	MOUNTING	FINISH	OPTIONS
27 - 2700K 30 - 3000K 35 - 3500K 40 - 4000K	120 - 120V 277 - 277V UNV - 120V-277V	D1 - 1% dimming 0-10V DA ³ - DALI LTEA2W - Lutron 1% - 2 wire FP 120V LDE1 ³ - Lutron Hi-lume 1% Eco LDE5 ³ - Lutron 5% EcoSystem ELD1 - eldoLED 1% ECOdrive ELDO - eldoLED 0.1% SOLOdrive ² PoE (Power-over-Ethernet) compatible. Consult factory for details. ³ On-site commissioning is required.	1 - 1 circuit +GTD - Generator transfer device	TG9 - Tegular 9/16" TG15 - Tegular 15/16" TB9 - T-Bar 9/16" TB15 - T-Bar 15/16" ST - Screw slot t-bar DF - Drywall kit	W - Matte white WA - White antimicrobial Silverwerx	FU - Fuse CP - Chicago Plenum GATR ⁴ - Gasketed construction with acrylic lens and tamper-resistant screws GPTR ^{4,5} - Gasketed construction with polycarbonate lens and tamper-resistant screws PTR ⁵ - Polycarbonate lens with tamper-resistant screws NA - None ⁴ IP54 rated when specified with gasketed construction and drywall ceiling mounting options. ⁵ IK10 rated when specified with polycarbonate lens.

CROSS SECTION

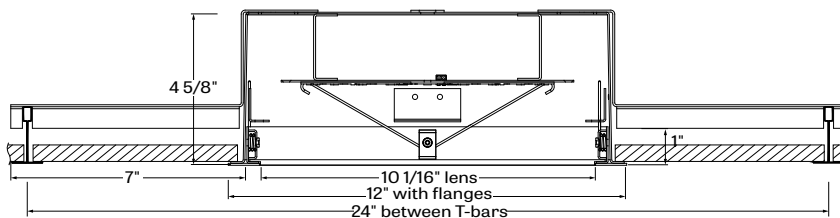

POROR + FH - pop round recessed with flush lens

3737 Cote Vertu St-Laurent, Quebec, Canada H4R 2C9
T (514) 225-4304 F (514) 931-4862
www.lumenwerx.com



Lumenwerx reserves the right to modify product specifications without notification.
© Lumenwerx, ULC. All rights reserved.
POPRESSED12-ROUND-SPEC-REV1- March 15, 2021



POP RECESSED

LUMENWERX

ROUND 12

STATIC WHITE, FULL SPECTRUM

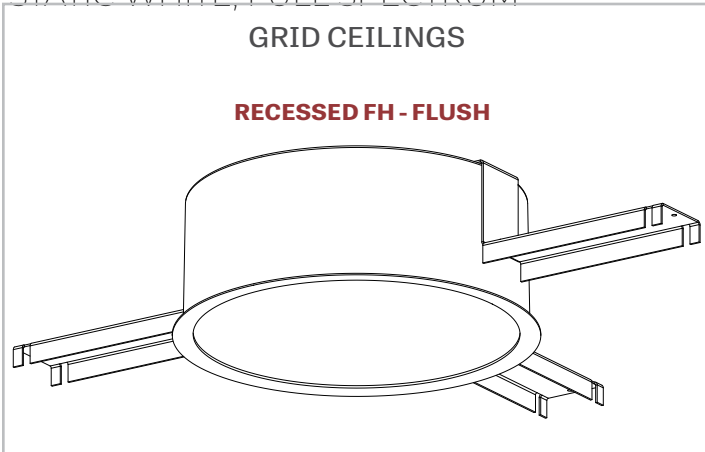

POROR - TC9 - tegular 9/16"

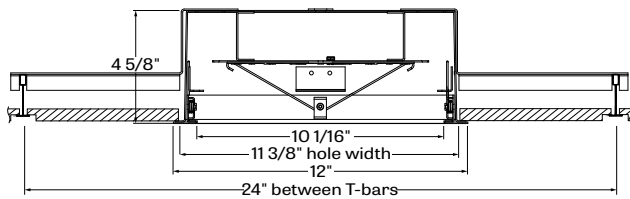

POROR - TB15 - t-bar 15/16"

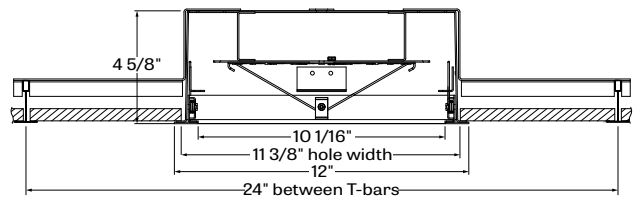

POROR - TG15 - tegular 15/16"

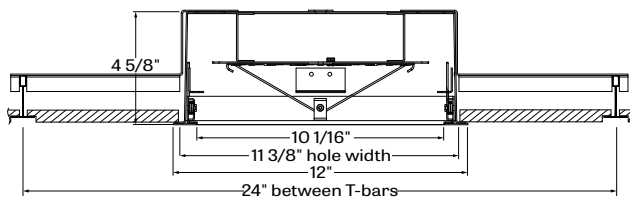

POROR - ST - screw slot t-bar

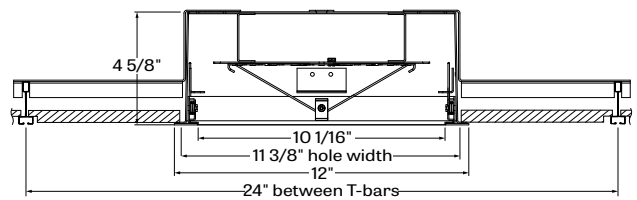

POROR - TB9 - t-bar 9/16"

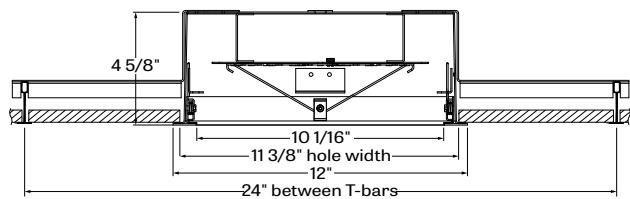

POROR - DF - drywall kit

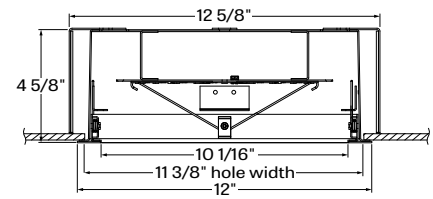

POP RECESSED

LUMENWERX

ROUND 12

STATIC WHITE, FULL SPECTRUM

OPTICS

UNIFORM EFFICIENCY LAMBERTIAN OPTIC (ULO) - made of formed impact modified white PMMA, the optic provides an even light distribution with up to 88% transmission. Its unique enclosed shell design protects LEDs against Electrostatic Discharge and dust while its back surface project a soft glow on the mounting surface.

LIGHT SOURCE - STATIC WHITE

Custom array of mid-flux LEDs are mounted directly to the housing for optimal thermal performance. Available in 2700K, 3000K, 3500K and 4000K with a minimum 80 CRI and an option for 90 CRI with elevated R9 value. Color consistency maintained to within 3 SDCM. LEDs operated at reduced drive current to optimize efficacy and lumen maintenance.

All LEDs have been tested in accordance with IESNA LM-80-08 and the results have shown L80 lumen maintenance greater than 60,000 hours. Absolute product photometry is measured and presented in accordance with IESNA LM-79, unless otherwise indicated.

PERFORMANCE AT 4000K

LED output	Color Temp	Watts	Nominal Delivered Lumens	Efficacy LPW
Low output	4000K	7.5	750	101
Medium output	4000K	9	900	99
High output	4000K	11	1100	100

LIGHT SOURCE - FULL SPECTRUM

The full spectrum LED option offers improved color particularly in the cyan region that is beneficial in both healthcare and circadian lighting strategies. The cyan region in full spectrum LED is richer at the 480 nm range.

ELECTRICAL

Factory-set, adjustable output current LED driver with universal (120-277VAC) input. Dimmable from 100% to 1% with 0-10V dimming control. Rated life (90% survivorship) of 50,000 hours at 50°C max. ambient (and 70°C max. case) temperature. At maximum driver load: Efficiency>84%, PF>0.9, THD<20%. Other specifiable options include Lutron Hi-Lume 1% (specify 2-wire, or Ecosystem Dim-to-Off), Lutron 5-Series (5% Ecosystem), eldoLED 1% ECOdrive, eldoLED 0.1% SOLOdrive, and DALI protocol drivers. All of our standard 0-10V drivers are NEMA 410 compliant.

PoE

Depending on the PoE manufacturer selected, Lumenwerx will install the node in factory as either integral to the luminaire or as a remote module. Factory programming of the PoE node may or may not enable the following functionalities: lumen package, Duo (tunable white), emergency battery backup, and sensor integration. These must be addressed and evaluated on a case-by-case basis.

MOUNTING OPTIONS

Recess mount into exposed or concealed T-Bar or Tegular grid ceiling. A separate kit for mounting fixtures into drywall ceilings.

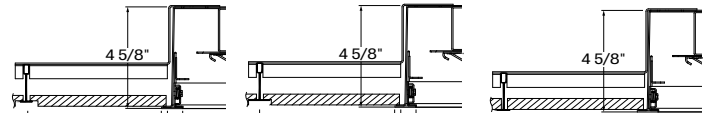

TG9 - tegular 9/16"

TG15 - tegular 15/16"

TB9 - t-bar 9/16"

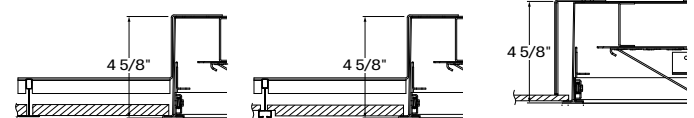

TB15 - t-bar 15/16"

ST - screw slot t-bar

DF - drywall kit

FINISH

Interior - 95% reflective, matte white powder coating

Exterior - matte white powder coating. Optional antimicrobial finish

GASKETED CONSTRUCTION OPTION

The lens is gasketed and sealed, making the fixture suitable for healthcare applications. IP54 rated when specified with the drywall ceiling mounting option.

CONSTRUCTION

Housing - 16 gauge spun aluminum, matte white powder coating

Diffuser - Uniform Lambertian optic, thermoformed impact modified acrylic, completely enclosed

Gasket (GATR, GPTR options) - Closed-cell silicone foam gasket

WEIGHT

RD 12 Flush - 4.24lbs - 1.93kg

CERTIFICATIONS

ETL - Rated for Indoor Dry/Damp locations. Conforms to UL Standard 1598 and certified to CAN/CSA Standard C22.2 No. 250.0.

Chicago plenum - City of Chicago Approved (CCEA)

IC rated - suitable for direct contact with insulation.

NSF - NSF2 Listed for Non-Food Zones.

WARRANTY

Lumenwerx provides a five-year limited warranty of electrical and mechanical performance of the luminaires, including the LED boards, drivers, and auxiliary electronics. Lumenwerx will repair or replace defective luminaires or components at our discretion, provided they have been installed and operated in accordance with our specifications. Other limitations apply, please refer to the full warranty on our website.

POP RECESSED

LUMENWERX

ROUND 12

STATIC WHITE, FULL SPECTRUM

750 LUMEN AT 80CRI - LOW OUTPUT

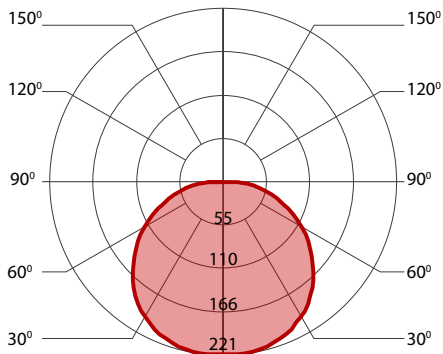

PERFORMANCE

LED output	Color Temp	Watts	Nominal Delivered Lumens	Efficacy LPW
Low output	2700K	8	750	93
Low output	3000K	8	750	95
Low output	3500K	7.5	750	98
Low output	4000K	7.5	750	101

900 LUMEN AT 80CRI - MEDIUM OUTPUT

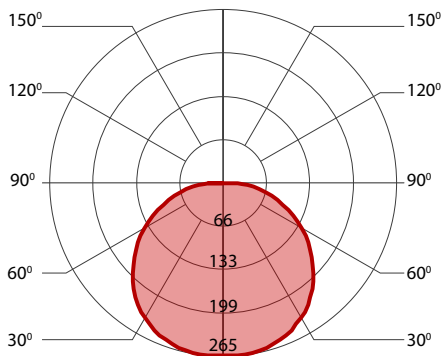

PERFORMANCE

LED output	Color Temp	Watts	Nominal Delivered Lumens	Efficacy LPW
Medium output	2700K	10	900	91
Medium output	3000K	9.5	900	93
Medium output	3500K	9.5	900	96
Medium output	4000K	9	900	99

1100 LUMEN AT 80CRI - HIGH OUTPUT

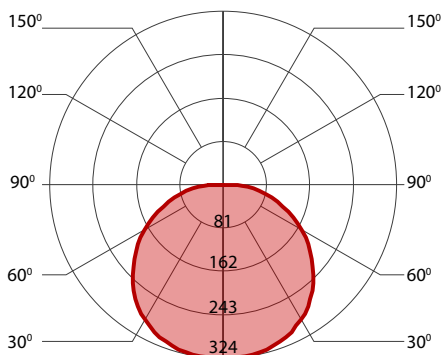

PERFORMANCE

LED output	Color Temp	Watts	Nominal Delivered Lumens	Efficacy LPW
High output	2700K	11.5	1100	95
High output	3000K	11.5	1100	94
High output	3500K	11.5	1100	97
High output	4000K	11	1100	100