

Voilà

True 2" Round Downlight
Fixed/Adjustable

LUMENWERX

Project: _____

Type: _____



Trimless



Trim

Voilà 2" round downlights feature innovative Hyflex™ optics for precise beam control. Shallow construction requires only a 4" recess depth. Driver can be replaced through 2" aperture. The Voilà COB source with 90 CRI and 2-step color consistency matches other Lumenwerx luminaires, and is available in Chromawerx SOLA (dim-to-warm) and DUO (tunable white). Complete Voilà offering includes 2" and 4" apertures; downlights, adjustables, and wall washers; round and square trim; and cylinders; see separate specifications.

Performance

LUMEN OUTPUT ¹	WATTS	EFFICACY LM/W
896 lm	7 W	128 lm/W
1103 lm	10 W	110 lm/W
1338 lm	14 W	96 lm/W

¹ Lumens packages are assuming 3500K, 80 CRI, 30° beam, round white baffle

Delivered Lumens for Round White Standard Baffles at 35K

CRI	90 CRI							
	10	20	30	40	50	60	75	90
Low - 7 W	496	487	822	795	785	730	684	656
Medium - 9.8 W	641	630	1012	978	966	898	841	807
High - 13.8 W	828	814	1228	1187	1173	1090	1021	980



Some restrictions may apply.



Aperture Size

2.00"

Configurations



Fixed, adjustable & wall wash (see other spec sheets for all the configurations)

Baffle Depth



Standard 0.52" Deep 1.06"

Trim



Trim & Trimless

Baffle & Trim Flange Finishes

Textured matte white
Textured matte black
Mixed black & white
Custom RAL



Color Temperature

2700K
3000K
3500K
4000K
SOLA
DUO



Delivered 529-1338 lm
7-14 Watts, up to 128 lm/W

Integral Drivers

0-10V, TRIAC & ELV

Remote Drivers

Lutron, eldoLED and other drivers
Remote emergency battery pack

1 - Housing (Example: VO2RR-TRM-SW-OF-ASB-120-7W-DI)

Product Specification

LUMINAIRE ID	TRIM STYLE	LIGHT SOURCE	INSTALLATION TYPE	MOUNTING OPTION	VOLTAGE	WATTAGE (80 CRI) ²	DIMMING		
VO2RR									
VO2RR - Voila 2" Round Recessed	TRM - Flanged trim TLMP - Trimless drywall mudplate TLMW - Trimless millwork	SW - Static white SOLA - Dim-to-warm DUO - Tunable white	OF - Open frame type non-IC IC - IC rated CP - Chicago Plenum type-IC (CCEA)	ACB - Adjustable commercial bar hangers (grid and drywall) ASB - Adjustable standard bar hangers (grid and drywall) FMB - Flush mount bars (drywall only) AHC - Adjustable hat channel bars	120 - 120V UNV - 120V-277V 347 ¹ - 347V ¹ Available with remote 0-10V dimming options RD1 and RSD1 only. Consult factory for details.	7W - Low output 529-896 lm 10W - Medium output 683-1103 lm 14W - High output 883-1338 lm ² For delivered lumens and other CRI, see multiplier tables on page 3. SOLA 8W - Low output 560 lm (20° only) 13W - High output 740-900 lm (40° and up) DUO 5W - Low output 300 lm (20° only) 10W - High output 530-640 lm (40° and up)	INTEGRAL DI - 1% 0-10V ELV ³ - ELV 120V TRI ³ - TRIAC 120V ³ Available with 120V only. SOLA SDI - Single 0-10V input	REMOTE RD1 - 1% 0-10V RELV ⁴ - ELV 120V RTRI ⁴ - TRIAC 120V RLTEA2W ^{4,5} - Lutron 1% - 2 wire FP 120V RLDE1 - Lutron Hi-Lume 1% Eco RLDE5 - Lutron 5% EcoSystem RDA - DALI RELD0 - eidoLED 0.1% RELD1 - eidoLED 1% ⁴ Available with 120V only. ⁵ Not available with 7W. SOLA RSD1 - Single 0-10V input DUO RDMX - To specify, see pages 7 to 9 RDDA - DALI RDD1 - Dual 0-10V input for CCT/Intensity RPSQ0 - Lutron T-Series 1% tunable white	+EB ⁶ - Emergency battery ⁶ Specify with remote dimming only. The code will be like the following example: RD1 + EB.

2 - Light (Example: VO2-SW-10-2-90-27-LS)

LUMINAIRE ID	LIGHT SOURCE	BEAM	COLOR QUALITY	CRI	COLOR TEMP	OPTION
VO2						
VO2 - Voila 2"	SW - Static white	10 - 10° Narrow spot 20 - 20° Spot 30 - 30° Narrow flood 40 - 40° Flood 50 - 50° Wide flood 60 - 60° Very wide flood 75 - 75° Very wide flood 90 - 90° Open flood	3 - 3 Step MacAdam Ellipse (for beam 10°&20°) 2 - 2 Step MacAdam Ellipse (for beam 30°-90°)	90 - 90 CRI 80 - 80 CRI 97 - 97 CRI (not available for 3500K, 10° and 20° beam angles)	27 - 2700K 30 - 3000K 35 - 3500K 40 - 4000K	LS ⁹ - Linear spread HEX ⁹ - Hex louver NA - None ⁹ Hex louver & linear spread cannot be combined together.
	SOLA - Dim-to-warm DUO - Tunable white	20 ⁷ - 20° Spot 40 ⁸ - 40° Flood 50 ⁸ - 50° Wide flood 60 ⁸ - 60° Very wide flood 75 ⁸ - 75° Very wide flood 90 ⁸ - 90° Open flood ⁷ Available with low output only. ⁸ Available with high output only.	3 - 3 Step MacAdam Ellipse	90 - 90 CRI (SOLA and DUO)	SOLA - Dim-to-warm 35K-22K DUO - Tunable white 27K-65K	

3 - Baffle (Example: VO2RRB-TRM-SDL-SR-TMW-TMW)

LUMINAIRE ID	TRIM STYLE ¹⁰	LENS ¹⁰	BAFFLE POSITION	BAFFLE FINISH ¹⁰	TRIM FLANGE FINISH ¹⁰
VO2RRB					
VO2RRB - Voila 2" Round Recessed Baffle	TRM - Flanged trim TLMP - Trimless drywall mudplate TLMW - Trimless millwork	SDL - Soft diffused lens FDL - Frosted diffused lens NOL - No lens	SR - Standard regress DR - Deep regress (fixed only)	TMW - Textured matte white TMB - Textured matte black CF# - Custom finish, specify RAL# (e.g. CF1028)	TMW ¹¹ - Textured matte white TMB ¹¹ - Textured matte black CF# ¹¹ - Custom finish, specify RAL# (e.g. CF1028) NA - None ¹¹ Applicable for TRM only.

¹⁰ IP44 rated for bathrooms, showers, outdoor canopies and marquees when specified with lens options (**SDL**, **FDL**), trim option (**TRM**), and the same finish for both the baffle and trim.

Photometrics

Please follow the multiplier tables to ensure correct lumen value. Beams, baffle color, lensing, CCT, CRI, baffle shape, baffle depth and accessories will change the lumen value.

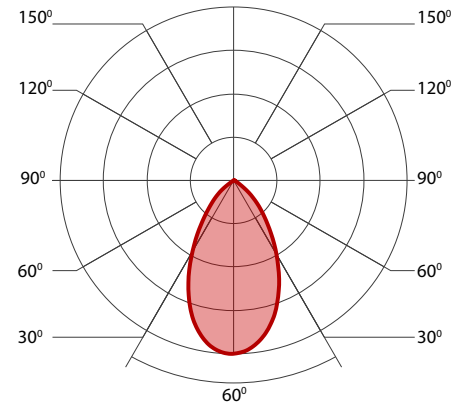
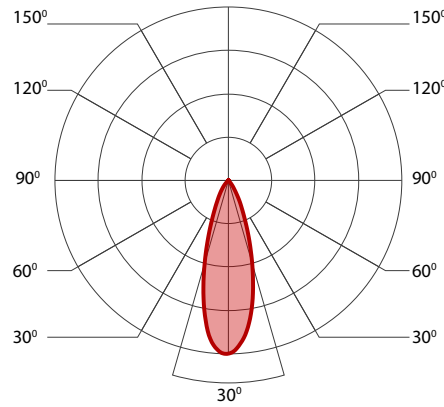
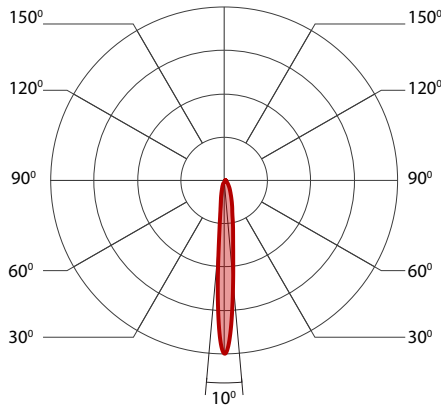

Delivered Lumens for Round White Standard Baffles - At 35K

CRI	80 CRI								90 CRI							
	10	20	30	40	50	60	75	90	10	20	30	40	50	60	75	90
Low - 7 W	537	529	896	869	859	795	748	711	496	487	822	795	785	730	684	656
Medium - 9.8 W	694	683	1103	1068	1057	978	921	876	641	630	1012	978	966	898	841	807
High - 13.8 W	897	883	1338	1297	1283	1187	1118	1062	828	814	1228	1187	1173	1090	1021	980

Delivered Lumens - At 30K

97 CRI							
10	20	30	40	50	60	75	90
NA	NA	607	588	675	628	589	564
NA	NA	870	841	830	771	724	695
NA	NA	1056	1021	1009	937	878	855

Efficacy Based on Delivered Lumens - High 13.8 W

BEAM	LPW							
	10	20	30	40	50	60	75	90
80 CRI	65	64	97	94	93	86	81	77
90 CRI	60	59	89	86	85	79	74	71
97 CRI	NA	NA	77	74	73	68	64	61

SOLA and DUO Max Wattage

BEAM	90 CRI							
	10	20	30	40	50	60	75	90
DUO	NA	5	NA	10	10	10	10	10
SOLA	NA	8	NA	13	13	13	13	13

Multiplier - CCT

CCT	
2700K	0.9
3000K	0.95
3500K	1
4000K	1.05

For SOLA and DUO, please consult factory.

Multiplier - Baffle Color, Shape and Depth

BAFFLE VARIABLES		
White	Round standard	1
White	Square standard	0.89
Black	Round standard	0.95
Black	Square standard	0.87
White	Round deep	0.96
White	Square deep	0.85
Black	Round deep	0.85
Black	Square deep	0.76

Multiplier - Optical Options

LENS AND LOUVERS	
No lens	1
Soft diffused lens	0.94
Frosted lens	0.78
Hex louvers	0.82

Technical Specification

DESCRIPTION Compact fixed or adjustable 2" downlight with multiple output, color, beam, and dimming options.

HOUSING CONSTRUCTION For new construction, 20 gauge powder coated steel. Open frame, type-IC, or Chicago Plenum (CCEA) rated. 18 gauge galvanized steel junction box with ½" trade size knockouts. Adjustable hanger bars and butterfly brackets are included. Hat channel and flush mounted brackets are also available.

Clearance Height: Open frame 4", IC and Chicago Plenum 4"

Ceiling Thickness: Can accommodate ½" to 1"

Housing weight: Type-IC/Chicago Plenum -7.5 lbs -3.4 kg

Open Frame - 5.5 lbs -2.5 kg

Ceiling cut out: 3 ¼" for square and round

FIELD REPLACEABLE LIGHT ELEMENT

Adjustability: Hot aiming, lockable, 360° rotation and 30° vertical tilt

LED Module: Integral COB module. 90 CRI and 2 SDCM, standard with options of 80 CRI, or 97 CRI. L80 > 60,000 hours

Light Output: From 537-1338 lumens

HyFlex™ Optics: Proprietary TIR/reflector with field interchangeable beam smoothing lenses.

Optical Accessories: Linear spread lens and hex cell louver can accommodate up to two in the light element.

Thermal Management: Cold-forged aluminum heat sink to maximize thermal dissipation.

BAFFLE

Die-cast aluminum retained ½" or 1" deep with rare earth magnets.

Trim style options: Round and square with flanged trim, trimless with mudplate for drywall, or trimless for millwork.

CHROMAWERX SOLA (dim-to-warm) and DUO (tunable white). See page 6 for more information.

ELECTRICAL

Integral: 0-10V, ELV, TRIAC.

Remote: 0-10V, ELV, TRIAC, Lutron EcoSystem, Lutron Hi-lume, DALI, eldoLED 0.1%, eldoLED 1%, DMX, Lutron T-Series (tunable white).

Emergency Options: Bodine emergency battery back-up is installed remotely. For 7W or 10W fixtures, battery provides 6W of power. For 14W fixtures, battery provides 10W of power.

ENVIRONMENT Ambient temperature at fixture location shall be within 0°C/32°F - 25°C/77°F, indoor dry or damp as well as outdoor damp use (canopies or marquees).

LISTING cETLus listed to UL 1598 Standard and CAN/CSA Standard C22.2 No. 250.0. IP44 rated for bathrooms, showers, outdoor canopies, and marquees when specified with lens options (SDL, FDL), trim option (TRM), and the same finish for both the baffle and trim.

WARRANTY 5 year limited warranty on LED module and power supply. Guaranteed to maintain 70% lumen maintenance.

Installation Types

Open Frame

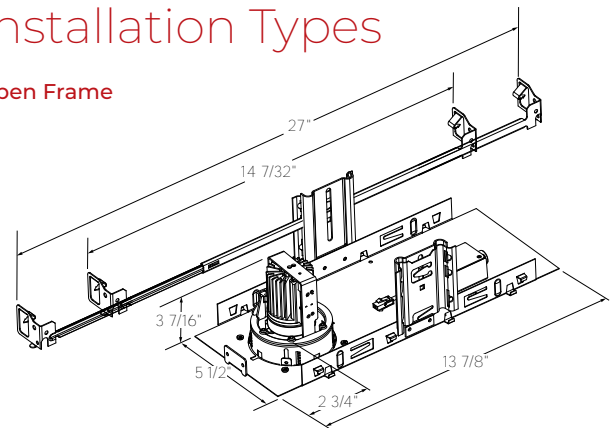

Type-IC / Chicago Plenum

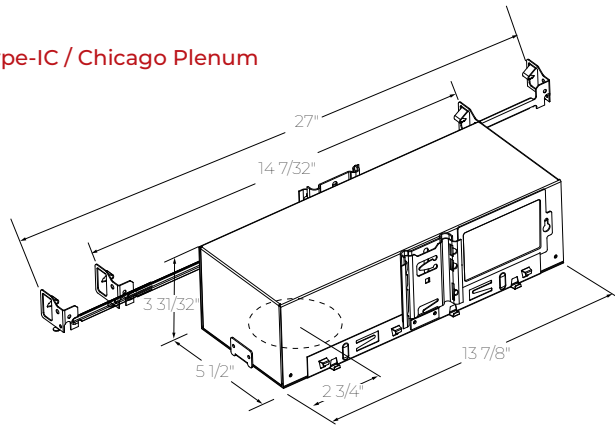

Mounting Options

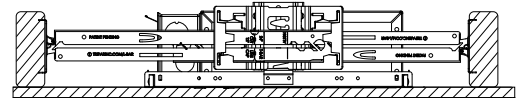

ACB - Adjustable Commercial Bar Hangers

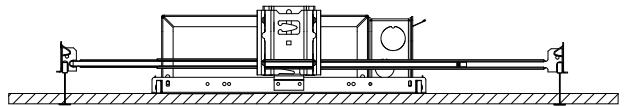

ASB - Adjustable Standard Bar Hangers



FMB - Flush Mount Bars

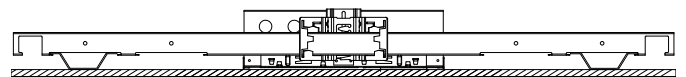

AHC - Adjustable Hat Channel Bars

Voilà

True 2" Round Downlight
Fixed/Adjustable

LUMENWERX

Project: _____

Type: _____

Light

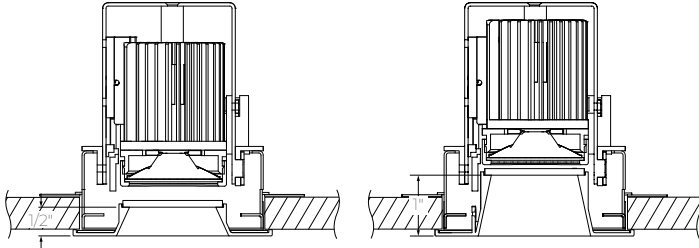

Standard Baffle

Deep Baffle

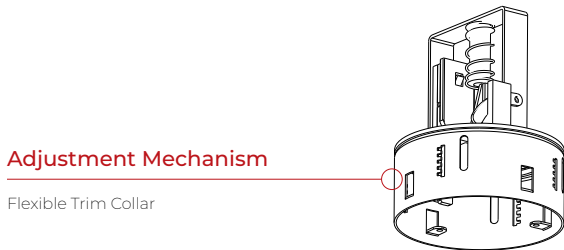

Adjustment Mechanism

Flexible Trim Collar

Light Element

Heat Sink
LED Module
Hyflex Optics

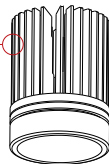

Optical Accessories (Optional)

Linear Spread
Hex Louver



Retaining Ring

Magnetic Snap

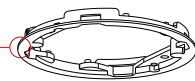

Baffle & Lens

Standard and Deep Regress
Soft Diffused
Frosted Diffused

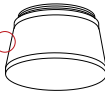

Trim

Trim and Trimless



Optics

Hyflex™ optics provide precise optical control in a remarkably compact form. The core of this four-tier system is a compound reflector with a central TIR element, just 1.06" deep. Beam smoothing discs perfect beam angles up to 90°. Beam angles are easily interchangeable in the field.

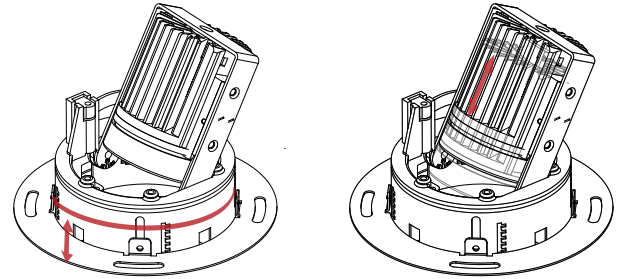

Adjustability

Adjustable Light Element rotates 360° and tilts up to 30°. Screw thread mechanism provides easy tilt adjustment, fixes the aiming angle, and is accessed by removing aperture trim. Supporting collar allows ceilings from 1/2" to 1" thick.

Light Source - LED

Compact COB (Chip-On-Board) LED module, available in 2700K, 3000K, 3500K and 4000K with a choice of 80 CRI or 90 CRI with elevated R9 value (for 97 CRI, consult factory). Color consistency is maintained to within 2 SDCM. All LEDs have been tested in accordance with IESNA LM-80-08 and the results have shown L80 lumen maintenance greater than 60,000 hours. Absolute product photometry is measured and presented in accordance with IESNA LM-79, unless otherwise indicated.

Beam Angles

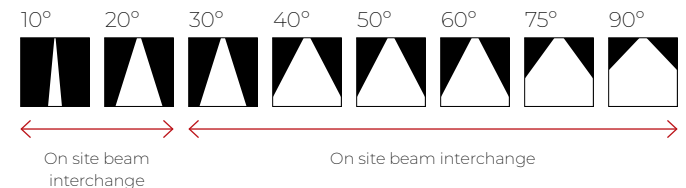

Options



Voilà

True 2" Round Downlight
Fixed/Adjustable

LUMENWERX

Project: _____

Type: _____

Integral Driver

Unless otherwise specified, Voilà comes standard with an integral, 120-277VAC/60Hz, electronic, 1% 0-10V dimming, constant-current LED driver. The driver is field replaceable and features a high power factor, low THD and sources 1 mA on the 0-10V dim line. All integral drivers are located inside the housing and are easily accessible from below the ceiling through the aperture. All dimming drivers comply with IEEE C62.41 surge protection requirements.

Emergency Remote

Long-life, high-temperature, emergency LED driver with Lithium Ion battery pack. Features a test switch with charge indicator, minimum of 90 minutes operation. For 7W or 10W fixtures, battery provides 6W of power. For 14W fixtures, battery provides 10W of power. Recharge time of 24 hours.

Trim Dimensions

Trimless

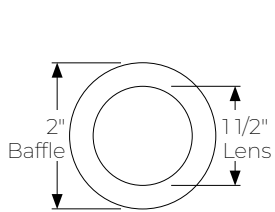

Trim

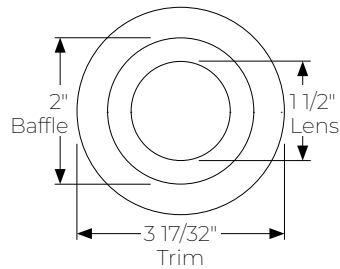

Chromawerx Sola is single-channel control that dims output while warming the color temperature in a pre-determined relationship. A simple or analog control adjusts a specially populated LED array to emulate the effect of dimming a filament source.



Chromawerx Duo offers a two-channel control system which uses analog or digital protocols for synchronous control of both warm (2700K) to cool (6500K) LED arrays - maintaining a CRI above 90. The range of color DUO offers is useful for entraining circadian rhythms, stimulating alertness, and compensating for jet lag among other applications. The Chromawerx drivers are programmed to limit maximum light output and power usage across all color temperatures.

Baffle



Standard Regress



Deep Regress

Trimless

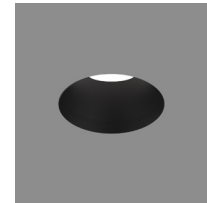
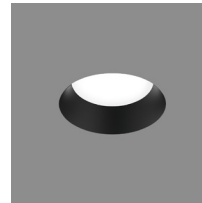

Black Baffle

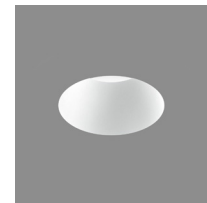
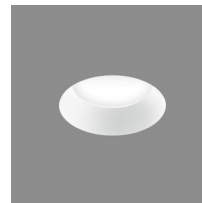

White Baffle

Trim

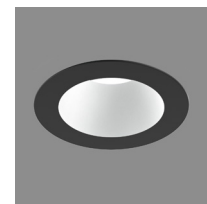
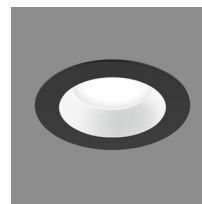

White Baffle, Black Trim

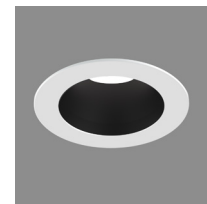
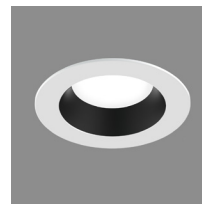

Black Baffle, White Trim

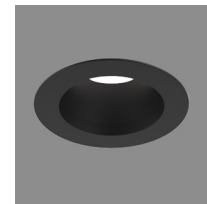
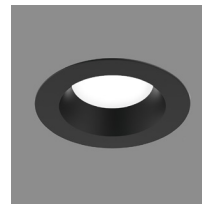

Black Baffle, Black Trim



White Baffle, White Trim

DUO GENERIC DMX NETWORK ARCHITECTURE

A qualified DMX integrator is required to assure proper installation and commissioning of the DMX network. **When placing the PO, please provide the contact information of your DMX integrator.**

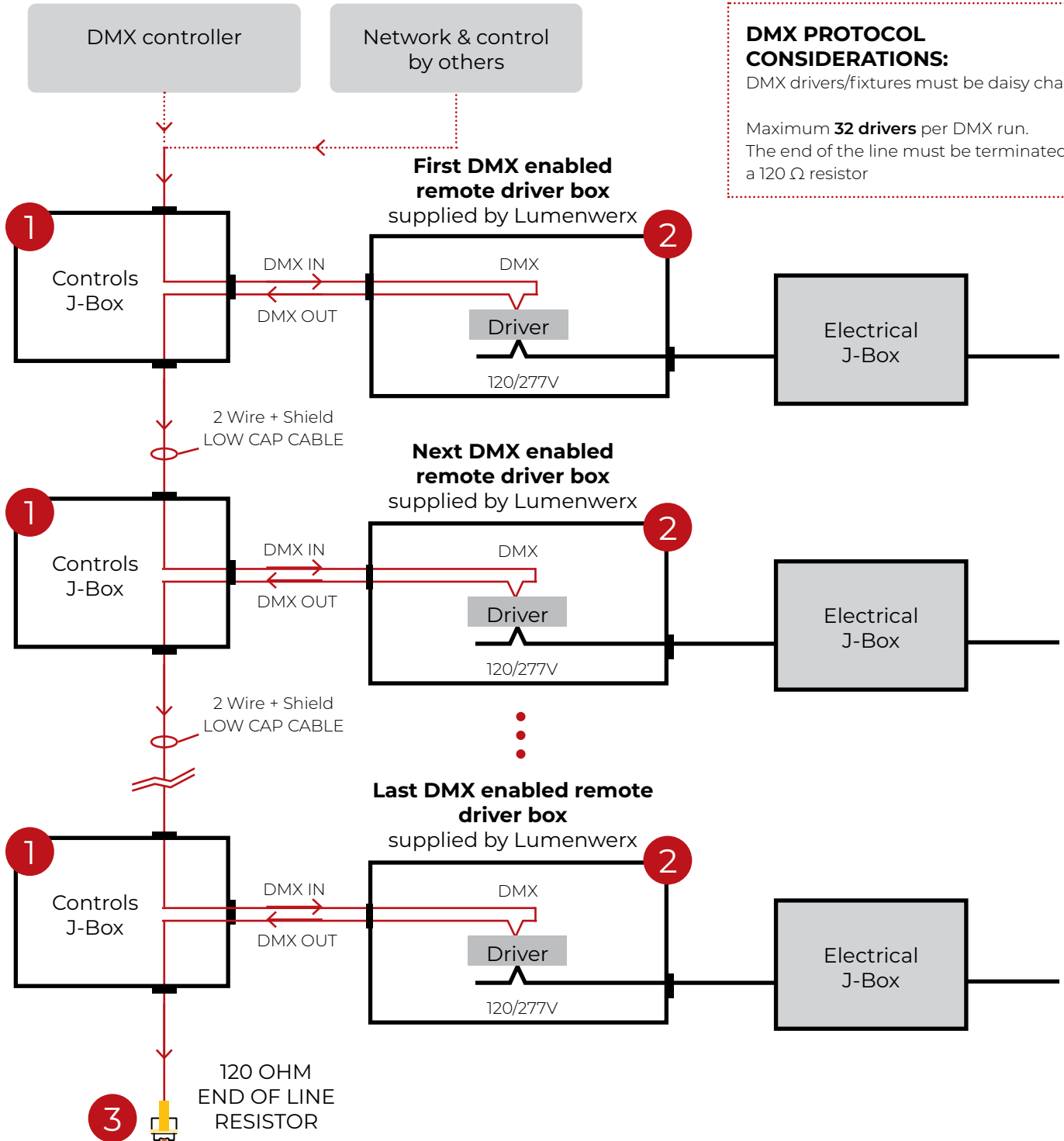

DMX PROTOCOL CONSIDERATIONS:
DMX drivers/fixtures must be daisy chained.

Maximum **32 drivers** per DMX run.
The end of the line must be terminated by a 120 Ω resistor

1 J-BOX DMX DAISY CHAIN DETAIL

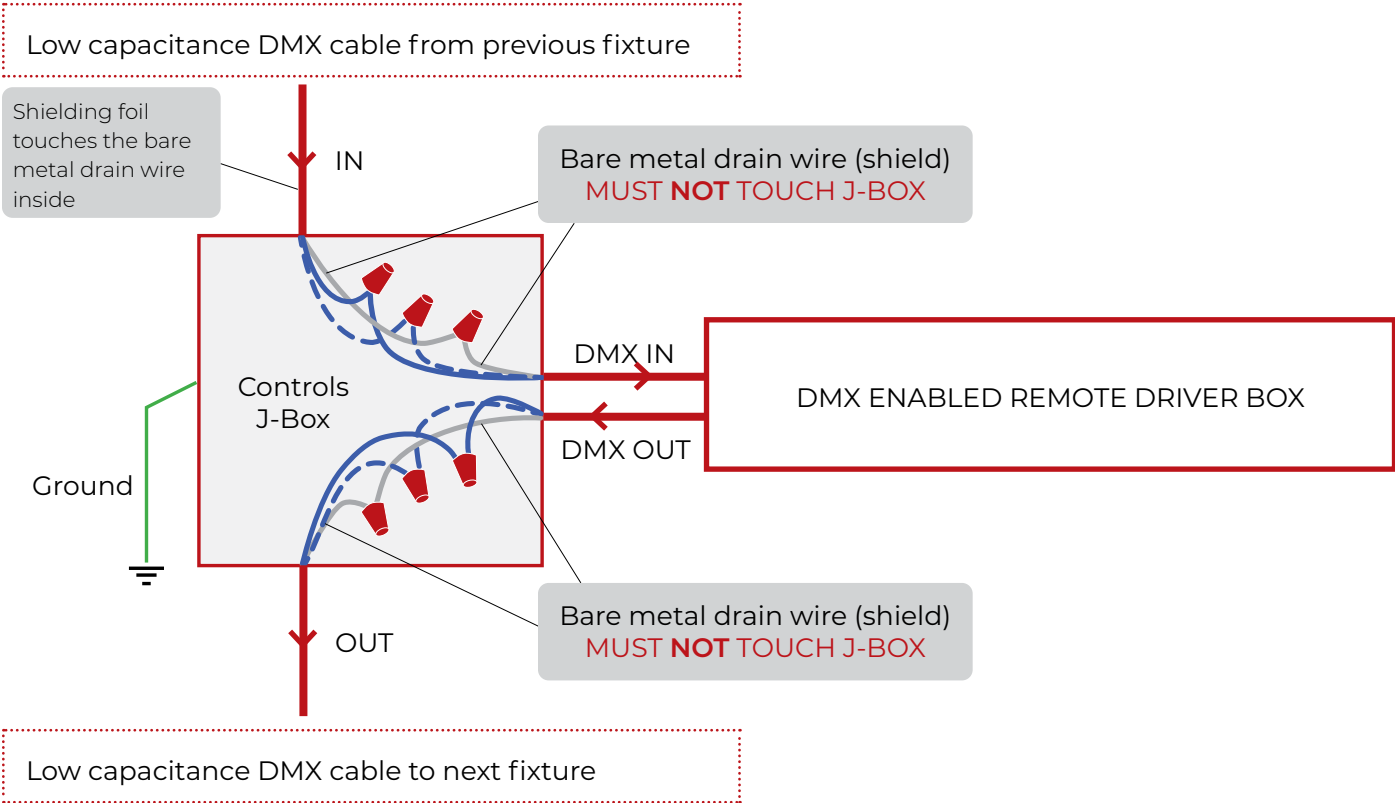

2 DMX CONNECTION REMOTE DRIVER

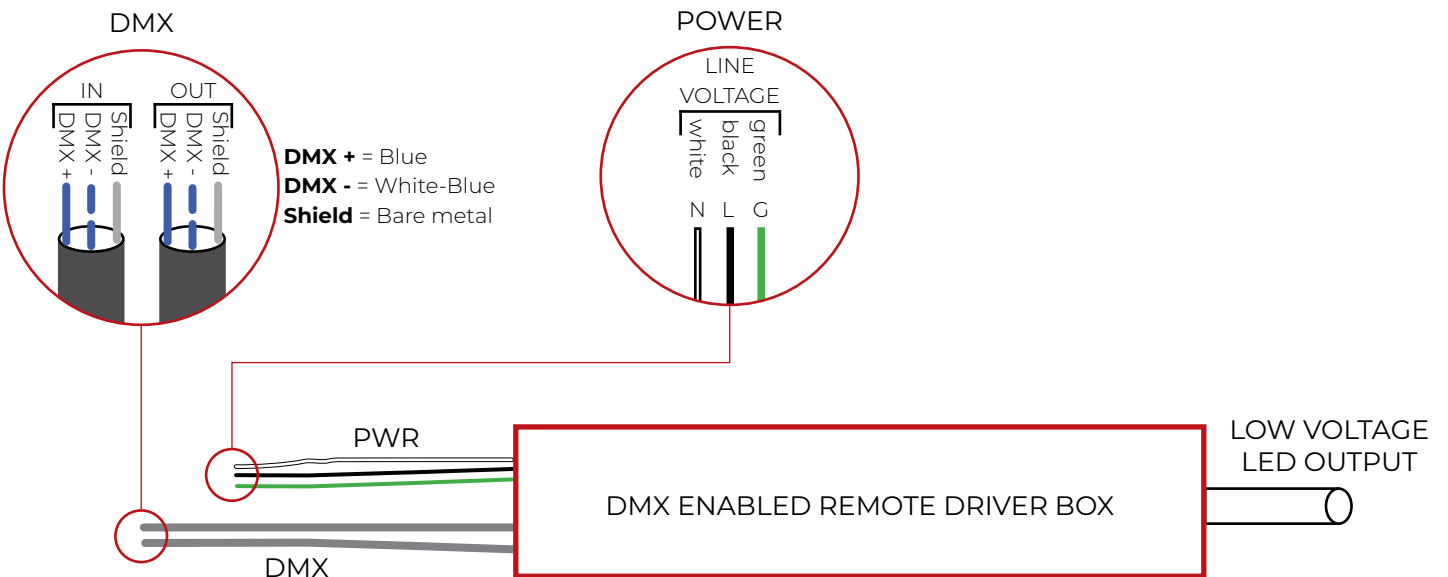

3 LAST DMX CONNECTION DETAIL

